



**Instructions for the following series products:**

EZ Stop Lanyards  
 ShockWave Lanyards  
 EZ Stop Retrax Lanyards

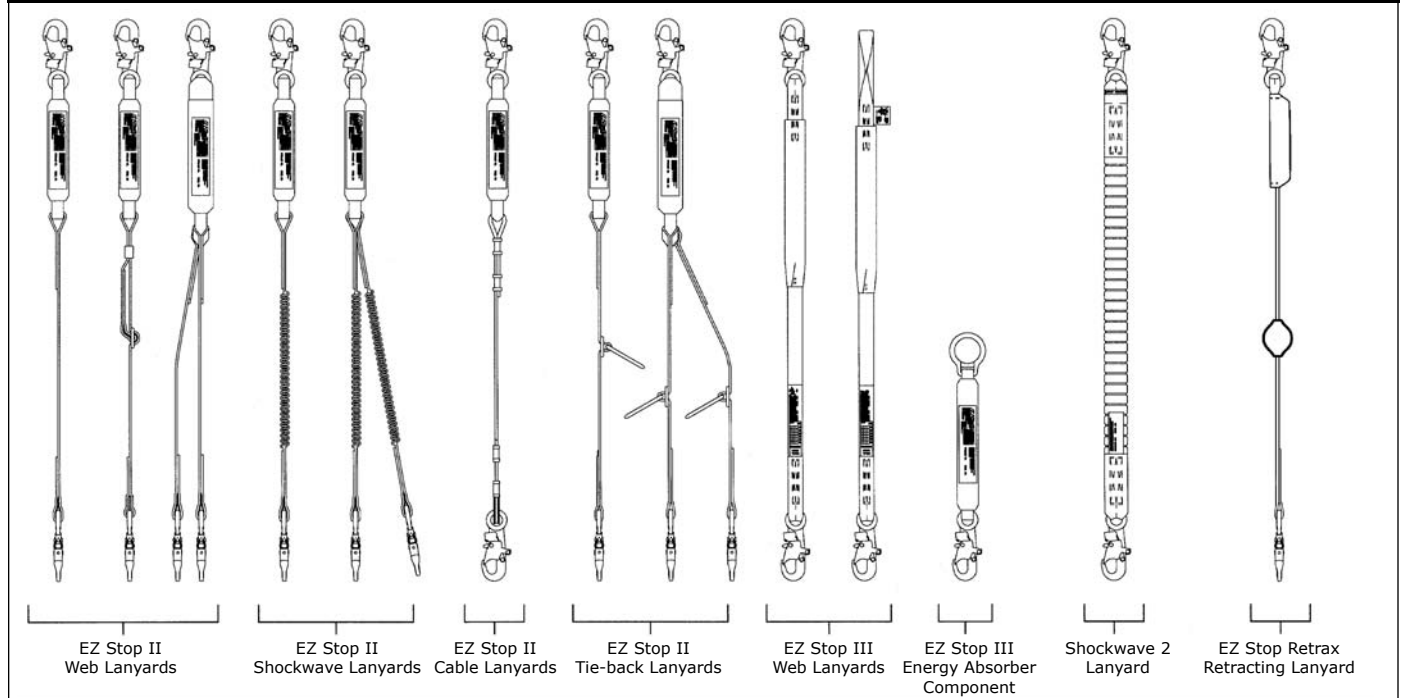
(See back pages for specific model numbers.)

**USER INSTRUCTION MANUAL**

**LANYARDS WITH INTEGRAL ENERGY ABSORBERS AND ENERGY ABSORBER COMPONENTS USED IN PERSONAL FALL ARREST SYSTEMS (ANSI Z359.1)**

This manual is intended to meet the Manufacturer's Instructions as required by ANSI Z359.1, and should be used as part of an employee training program as required by OSHA.

**Figure 1 - EZ STOP® Lanyards**



**WARNING:** This product is part of a personal restraint, work positioning, suspension, or rescue system. These instructions must be provided to the user and rescuer (see section 8 Terminology). The user must read and understand these instructions or have them explained to them before using this equipment. The user must read and follow the manufacturer's instructions for each component or part of the complete system. Manufacturer's instructions must be followed for proper use and maintenance of this product. Alterations or misuse of this product or failure to follow instructions may result in serious injury or death.

**IMPORTANT:** If you have any questions on the use, care, application, or suitability for use of this equipment, contact DBI-SALA.

**IMPORTANT:** Before using this equipment record the product identification information (found on the I.D. label) in the inspection and maintenance log in section 10.0 of this manual.

**DESCRIPTIONS**

**EZ STOP® II WEB LANYARDS**

- 1-in. (2.5 cm) web, 9503175 hook each end.
- 1-in. (2.5 cm) web, 9503175 hook one end, 2007153 hook other end.
- 1-in. (2.5 cm) web, 9503175 hook one end, 1200049 wire pipe clamp other end.
- 1-in. (2.5 cm) web, 9503175 hook one end, 2000108 carabiner other end.
- 1-in. (2.5 cm) web, web loop one end, 2007153 hook other end.
- 1-in. (2.5 cm) web, web loop one end, 9503175 hook other end.
- 1-in. (2.5 cm) web, adjustable, 9503175 hook each end.
- 1-in. (2.5 cm) web, 100% tie-off, 9503175 hook center, 2007153 hook leg ends.
- 1-in. (2.5 cm) web, 100% tie-off, 9503175 hook center and leg ends.
- 1-in. (2.5 cm) web, 100% tie-off, 9503175 hook center, 2000108 carabiner leg ends.
- 1-in. (2.5 cm) web, 100% tie-off, web loop center, 2007153 hook leg ends.
- 1-in. (2.5 cm) web, 100% tie-off, web loop center, 9503175 hook leg ends.

## **EZ STOP® II SHOCKWAVE™ WEB LANYARDS**

- 1-in. (2.5 cm) elastic web, 9503175 hook each end.
- 1-in. (2.5 cm) elastic web, 9503175 hook one end, 2007153 hook other end.
- 1-in. (2.5 cm) elastic web, web loop one end, 2007153 hook other end.
- 1-in. (2.5 cm) elastic web, web loop one end, 9503175 hook other end.
- 1-in. (2.5 cm) elastic web, 100% tie-off, 9503175 hook center and both ends.
- 1-in. (2.5 cm) elastic web, 100% tie-off, 9503175 hook center, 2007153 hook leg ends.
- 1-in. (2.5 cm) elastic web, 100% tie-off, web loop center, 2007153 hook leg ends.
- 1-in. (2.5 cm) elastic web, 100% tie-off, web loop center, 9503175 hook leg ends.

## **EZ STOP® II CABLE LANYARDS**

- 7/32-in. (.6 cm) cable, 9503175 snap hook each end.
- 7/32-in. (.6 cm) cable, 9503175 snap hook one end, 2007153 snap hook other end.
- 7/32-in. (.6 cm) cable, 9503175 snap hook one end, 2000108 carabiner other end.

## **EZ STOP® II TIE-BACK LANYARDS**

- 1-in. (2.5 cm) web, 9503175 hook both ends, floating D-ring.
- 1-in. (2.5 cm) web, 100% tie-off, 9503175 hook center and leg ends, floating D-rings.

## **EZ STOP® III WEB LANYARDS**

- 1 3/8-in. (3.5 cm) web, 9503175 hook each end.
- 1 3/8-in. (3.5 cm) web, 9503175 hook one end, 2007153 hook other end.
- 1 3/8-in. (3.5 cm) web, 9503175 hook one end, 2000108 carabiner other end.
- 1 3/8-in. (3.5 cm) web, 9503175 hook one end, 1200049 wire pipe hook other end.
- 1 3/8-in. (3.5 cm) web, web loop one end, 2007153 hook other end.
- 1 3/8-in. (3.5 cm) web, web loop one end, 9503175 hook other end.

## **EZ STOP® II ENERGY ABSORBER COMPONENT**

9503175 hook one end, D-ring one end, 24-in. length.

## **SHOCKWAVE 2™ WEB LANYARD**

- 1 15/16-in. (4.9 cm) web, 9503175 hook each end.
- 1 7/8-in. (4.8 cm) web, 9502116 hook one end, 9500810 hook other end

## **EZ STOP® RETRAX™ RETRACTING WEB LANYARD**

- 1 3/8-in. (3.5 cm) web, 9503175 hook each end.
- 1 3/8-in. (3.5 cm) web, 9503175 hook one end, 9510057 hook other end.
- 1 3/8-in. (3.5 cm) web, 9503175 hook one end, 2007153 hook other end.
- 1 3/8-in. (3.5 cm) web, 100% tie-off, 9503175 hook each end.

Note: Other hook and lanyard options are available.

## **1.0 APPLICATIONS**

- 1.1 PURPOSE:** DBI-SALA Energy Absorbing Lanyards and Energy Absorbers are intended to be used as part of a personal fall arrest system. Applications for these products include inspection work, construction and demolition, maintenance, oil production, confined space rescue, and similar activities where there exists the possibility of a fall. This equipment is specially designed to dissipate fall energy and limit fall arrest forces transferred to the body.
- 1.2 LIMITATIONS:** The following application limitations must be considered before using this product:
  - A. CAPACITY:** This equipment is for use by persons with a combined weight (person, clothing, tools, etc.) of no more than 310 lbs. (140.6 kg). CSA models meet Z25911-05 E4 or E6 classifications. See back cover for associated capacities and model numbers.
  - B. PHYSICAL AND ENVIRONMENTAL HAZARDS:** Use of this equipment in areas containing physical or environmental hazards may require that additional precautions be taken to reduce the possibility of damage to this equipment or injury to the user. Hazards may include, but are not limited to: high heat, strong or caustic chemicals, corrosive environments, the possibility of electric current flowing through this equipment when working near high voltage power lines, explosive or toxic gases, moving machinery, sever cold, or sharp edges. Contact DBI-SALA if you have any questions about the application of this equipment in areas where physical or environmental hazards are present.
  - C. TRAINING:** This equipment is intended to be installed and used by persons who have been properly trained in its correct application and use.
- 1.3** Refer to national standards including ANSI Z359 (.0, .1, .2, .3, and .4), family of standards on fall protection, ANSI A10.32, and applicable local, state, and federal (OSHA) requirements governing occupational safety for more information on Energy Absorbing Lanyards, Energy Absorbers and associated components. In Canada, see the Z259 group of CSA Standards.

## 2.0 SYSTEM REQUIREMENTS

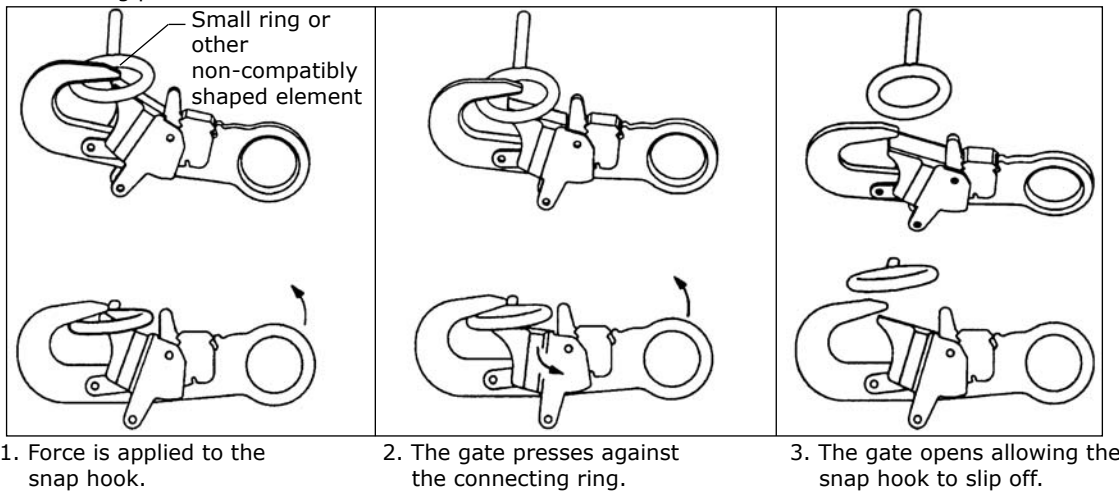
**2.1 COMPATIBILITY OF CONNECTORS:** DBI-SALA equipment is designed for use with DBI-SALA approved components and subsystems only. Substitutions or replacements made with non-approved components or subsystems may jeopardize compatibility of equipment and may effect the safety and reliability of the complete system.

**COMPATIBILITY:** Connectors must be compatible with the anchorage or other system components. Do not use equipment that is not compatible. Non-compatible connectors may unintentionally disengage. See Figure 2. Connectors must be compatible in size, shape, and strength regardless of orientation. Self-locking snap hooks and carabiners are required by ANSI Z359.1 and OSHA. Contact DBI-SALA if you have any questions about compatibility.

Connectors ( hooks, carabiners, and D-rings) must be capable of supporting a tensile load of at least 5,000 lbs. (22.2 kN). Per ANSI Z359.1, connector gates must be able to withstand a load of 3,600 lbs (16 kN): the face of the gate must withstand 3,600 lbs (16 kN); the side of the gate must withstand 3,600 lbs (16kN), and the minor axis of a snap hook or carabiner must withstand 3,600 lbs (16 kN), except for those with captive eyes.

**Figure 2 - Unintentional Disengagement (Roll-out)**

If the connecting element that a snap hook (shown) or carabiner attaches to is undersized or irregular in shape, a situation could occur where the connecting element applies a force to the gate of the snap hook or carabiner. This force may cause the gate (of either a self-locking or a non-locking snap hook) to open, allowing the snap hook or carabiner to disengage from the connecting point.



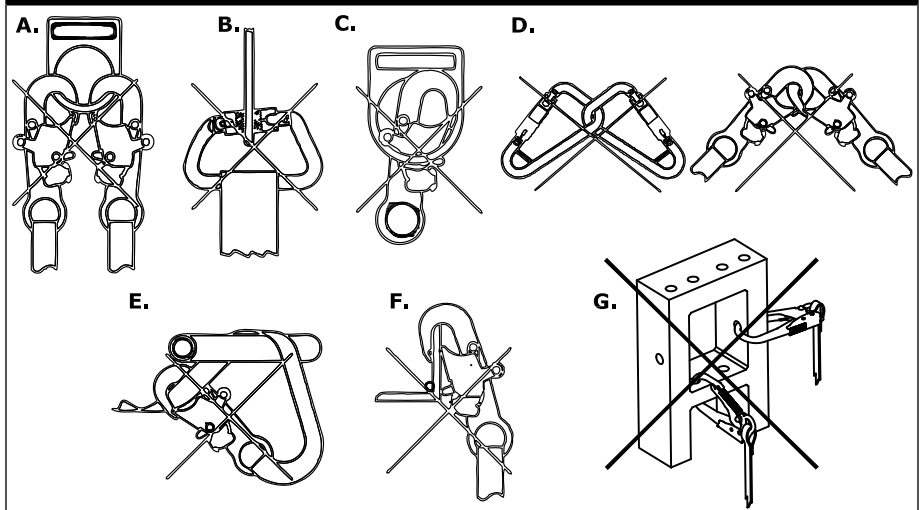
**2.2 MAKING CONNECTIONS:** Only use self-locking snap hooks and carabiners with this equipment. Only use connectors that are suitable to each application. Ensure all connections are compatible in size, shape and strength. Do not use equipment that is not compatible. Ensure all connectors are fully closed and locked.

DBI-SALA connectors (snap hooks and carabiners) are designed to be used only as specified in each product's user instructions. See Figure 3 for inappropriate connections. DBI-SALA snap hooks and carabiners should not be connected:

- A. To a D-ring to which another connector is attached.
- B. In a manner that would result in a load on the gate.

**NOTE:** Large throat-opening snap hooks should not be connected to standard size D-rings or similar objects which will result in a load on the gate if the hook or D-ring twists or rotates. Large throat snap hooks are designed for use on fixed structural elements such as rebar or cross members that are not shaped in a way that can capture the gate of the hook.

**Figure 3 - Inappropriate Connections**



- C. In a false engagement, where features that protrude from the snap hook or carabiner catch on the anchor, and without visual confirmation seems to be fully engaged to the anchor point.
- D. To each other.
- E. Directly to webbing or rope lanyard or tie-back (unless the manufacturer's instructions for both the lanyard and connector specifically allows such a connection).
- F. To any object which is shaped or dimensioned such that the snap hook or carabiners will not close and lock, or that roll-out could occur.
- G. In a manner that does not allow the connector to align with the fall arrest device (i.e., lanyard) while under load.

**2.3 ANCHORAGE STRENGTH:** In accordance with ANSI Z359.1, anchorages selected for fall arrest systems shall have a strength capable of sustaining static loads applied in the directions permitted by the system of at least:

- A. 5,000 pounds (22.2kN) for non-certified anchorages, or
- B. Two times the maximum arresting force for certified anchorages.

When more than one fall arrest system is attached to an anchorage, the strengths set forth in (A) and (B) above shall be multiplied by the number of systems attached to the anchorage.

**WARNING:** Anchorages must be rigid. Large deformations of the anchorage will affect system performance, and may increase the required fall clearance below the system, which could result in serious injury or death.

From OSHA 1926.500 and 1910.66: Anchorages used for attachment of PFAS shall be independent of any anchorage being used to support or suspend platforms, and capable of supporting at least 5,000 lbs. (22.2 kN) per user attached, or be designed, installed, and used as part of a complete PFAS which maintains a safety factor of at least two, and is supervised by a qualified person  
Anchorages selected for work positioning systems shall have a strength capable of sustaining static loads applied in the directions permitted by the system of at least:

- A. 3,000 pounds (13.3kN) for non-certified anchorages, or
- B. Two times the foreseeable force for certified anchorages.

When more than one work positioning system is attached to an anchorage, the strengths set forth in (A) and (B) above shall be multiplied by the number of systems attached to the anchorage.

### 3.0 OPERATION AND USE

**WARNING:** Do not alter or intentionally misuse this equipment. Consult DBI-SALA when using this equipment in combination with components or subsystems other than those described in this manual. Some subsystem and component combinations may interfere with the operation of this equipment. Use caution when using this equipment around moving machinery, electrical hazards, chemical hazards, and sharp edges. Do not loop the lanyard around small structural members.

**WARNING:** Working at height has inherent risks. Some risks are noted here but are not limited to the following: falling, suspension/prolonged suspension, striking objects, and unconsciousness. In the event of a fall arrest and/or subsequent rescue (emergency) situation, some personal medical conditions may affect your safety. Medical conditions identified as risky for this type of activity include but are not limited to the following: heart disease, high blood pressure, vertigo, epilepsy, drug or alcohol dependence, psychiatric illness, impaired limb function and balance issues. We recommend that your employer/physician determine if you are fit to handle normal and emergency use of this equipment

**3.1 BEFORE EACH USE** of this equipment, carefully inspect it to assure that it is in good working condition. Check for worn or damaged parts. Ensure all hardware is present and secure, and is not distorted or have any sharp edges, burrs, cracks, or corrosion. Ensure self-locking snap hooks or carabiners work properly. Inspect rope or webbing for wear, cuts, burns, frayed edges, breaks, or other damage. See section 5.0 for further inspection details. Do not use if inspection reveals an unsafe condition.

**3.2 PLAN** your fall protection system before starting your work. Take into consideration factors that affect your safety before, during, and after a fall. The following list gives some important points to consider when planning your system:

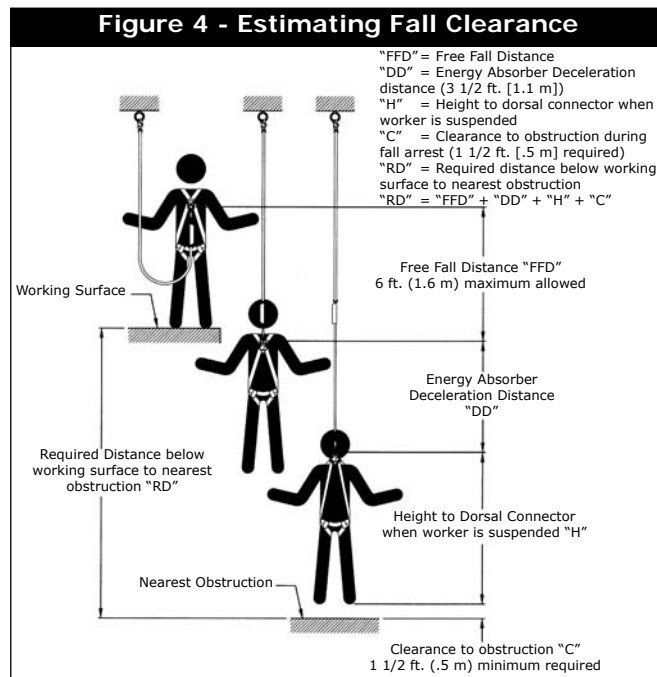
- A. **ANCHORAGE:** Select a rigid anchorage point that is capable of supporting the required loads. See section 2.3. The anchorage location must be carefully selected to reduce possible free fall and swing fall hazards and to avoid striking an object during a fall. The anchorage should be generally level (horizontal) to prevent the anchorage connector from sliding down an incline when in use, which could cause serious injury to the user.

- B. FREE FALL:** Personal fall arrest systems must be rigged such that the potential free fall is never greater than 6 ft. (1.8 m). Avoid working above your anchorage level to avoid an increased free fall distance.

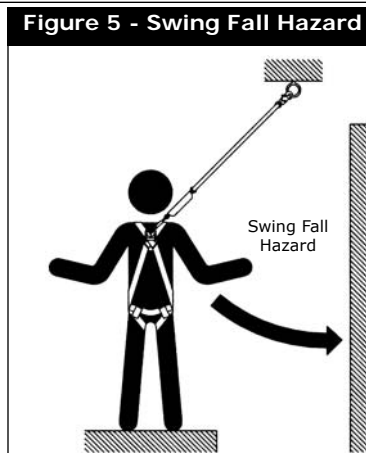
**IMPORTANT:** Some energy absorbing lanyards, such as EZ Stop® Retrax™ and the Shockwave lanyards, make use of retracting devices designed to shorten their free length. These devices do not decrease free fall distance

- C. FALL ARREST FORCES:** The assembled fall arrest system must keep fall arrest forces below 1,800 lbs. (8.0 kN) when used with a full body harness.

- D. FALL CLEARANCE:** Should a fall occur, there must be sufficient clearance in the fall area to arrest the fall before striking the ground or other object. Energy absorbers can extend the fall arrest distance by up to 42 inches (106.7 cm). Figure 4 shows how to estimate fall clearance distance when using an energy absorbing lanyard or energy absorber subsystem. Other factors may influence the required clearance distances. For example, using an energy absorbing lanyard or energy absorber with a rope grab (fall arrestor) may require additional clearance due to stretch in the lifeline or sliding of the rope grab on the lifeline during fall arrest. Some full body harness models incorporate a sliding (positional) D-ring in the back as the fall arrest attachment, movement of this D-ring during fall arrest can increase the fall clearance distance required. Use caution when assembling system components that could act to extend the fall arrest distance (and therefore fall clearance required). Refer to manufacturer's instructions for each part of the system for more information on fall clearance.



- E. SWING FALLS:** Swing falls occur when the anchorage point is not directly above the point where a fall occurs. The force of striking an object while swinging (horizontal speed of the user due to the pendulum effect) can be great and may cause serious injury. In a swing fall situation, the total vertical fall distance of the user will be greater than if the user had fallen vertically directly below the anchorage point. The user must therefore account for an increase in the total free fall distance and the area needed to safely arrest the fall. Swing falls can be minimized by working as directly below the anchorage point as possible. Never permit a swing fall if injury could occur. If a swing fall situation exists in your application contact DBI-SALA before proceeding. See Figure 5.



- F. SHARP EDGES:** Avoid working where the lanyard, subsystem, or other system components will be in contact with, or abrade against, unprotected sharp edges. Do not loop lanyard around small diameter structural members. If working with this equipment near sharp edges is unavoidable, protection against cutting must be provided by using a heavy pad or other means over the exposed sharp edge.
- G. RESCUE:** The user (employer) must have a rescue plan and the ability to implement it when using this equipment
- H. AFTER A FALL:** Lanyards with integral energy absorbers, or energy absorber components which have been subjected to the forces of arresting a fall must be removed from service and destroyed. See Figure 18.

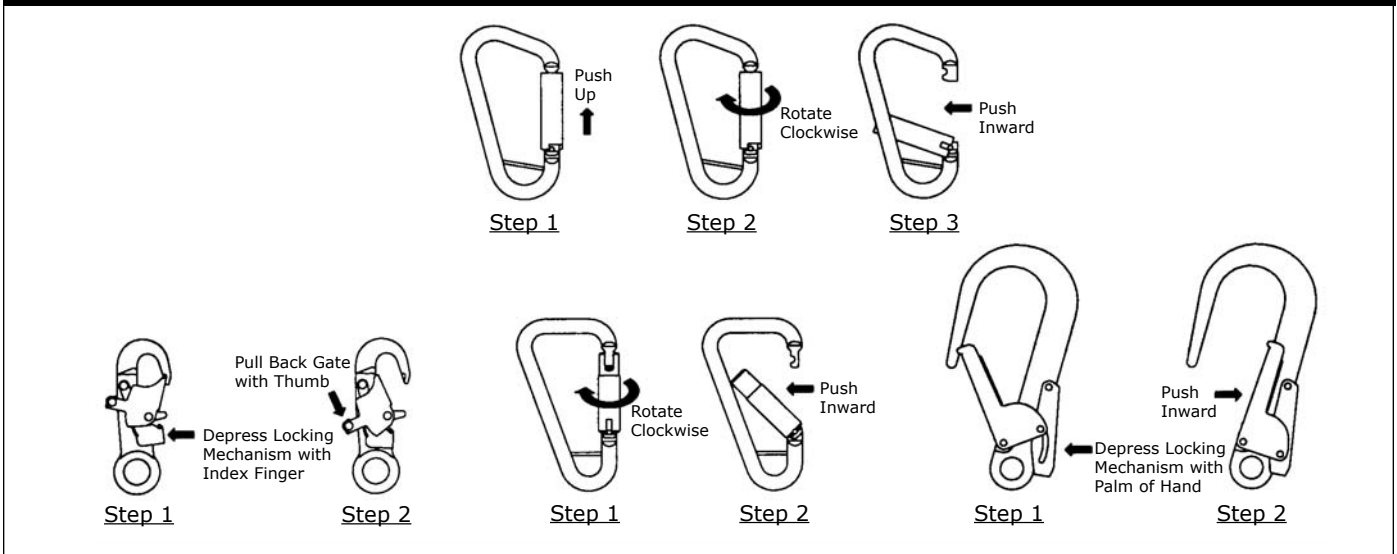
**WARNING:** Read and follow manufacturer's instructions for associated equipment (full body harness, rope grab, etc.) used in your fall protection system.

**IMPORTANT:** For special (custom) versions of this product, follow the instructions herein. If included, see supplement for additional instructions.

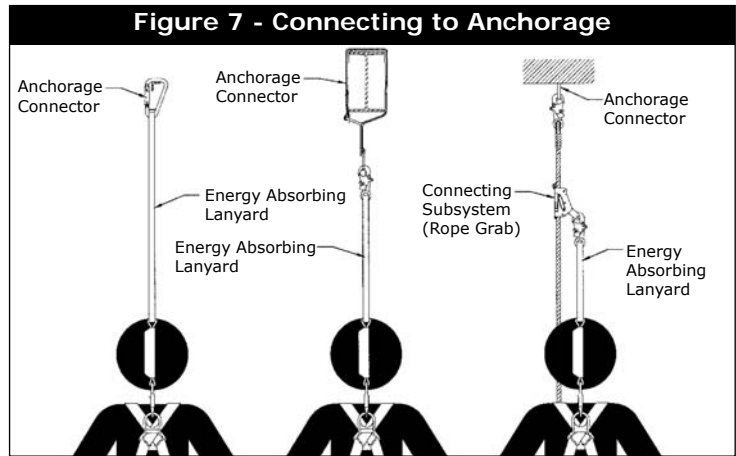
- 3.3 MAKING CONNECTIONS:** See Figure 6 for hook operation. When using a hook to connect to an anchorage, or when coupling components of the system together, ensure accidental disengagement (roll-out) cannot occur. Roll-out occurs when interference between a hook and the mating connector causes the hook's gate or keeper to accidentally open and release. Roll-out may occur when a hook is connected to an undersized ring such as an eye bolt or other non-compatible shaped connector. Self-locking snap hooks or self-locking and self-closing gate carabiners should be used to reduce the possibility of roll-out when making connections. Do not use hooks or connectors that will not completely close over the attachment object. For

these situations, use a tie-off adaptor or other anchorage connector to allow a compatible connection. Do not knot the lanyard in any manner, and do not hook the lanyard back into itself (choker style). Snap hooks and carabiners must not be connected to each other. Do not attach snap hooks to web loops.

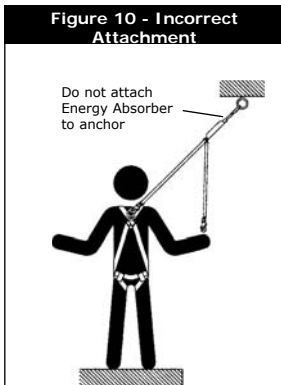
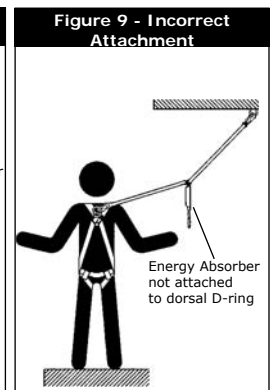
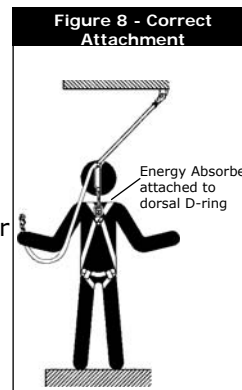
**Figure 6 - Making Connections**



**A. CONNECTING TO ANCHORAGE OR ANCHORAGE CONNECTOR:** See Figure 7. Always connect the energy absorber end of the lanyard to the body support (harness). Connect the lanyard end to the anchorage or anchorage connector. Component style energy absorbers should be connected to the body support first, then coupled to the rest of the system. Some anchorage connector devices may be supplied with permanently attached energy absorber. Use of an additional energy absorber or energy absorbing lanyard with these types of subsystems is not recommended.



100% Tie-off Lanyard Considerations: Commonly known as 100% tie-off, "Y" type, twin leg, or double lanyards; these energy absorbing lanyards can be used to provide continuous fall protection while ascending, descending, or moving laterally. With one lanyard leg attached, the worker can move to a new location, attach unused lanyard leg, and disconnect attached leg. This procedure is repeated until a new location is reached. With the EZ Stop® II Shockwave 100% tie-off type lanyard, only one leg of the lanyard shall be attached to the anchorage or anchorage connector once a working location is reached. Other practices that must be followed in order to use a 100% tie-off type lanyard safely include:



1. The energy absorber portion of the lanyard must be connected to the dorsal D-ring only. Use only the snap hook (or other connector provided) to attach the energy absorber portion directly to the harness dorsal D-ring. See Figures 8 and 9.
2. Do not connect the energy absorber to the anchorage. See Figure 10.
3. Do not attach the unused leg of the lanyard back to the harness at any location unless a specially designed lanyard retainer is provided for this purpose. See Figure 11.
4. Connection of both lanyard legs to separate anchorage points is acceptable. See Figure 12.

Figure 11 - Acceptable Designed Retainers

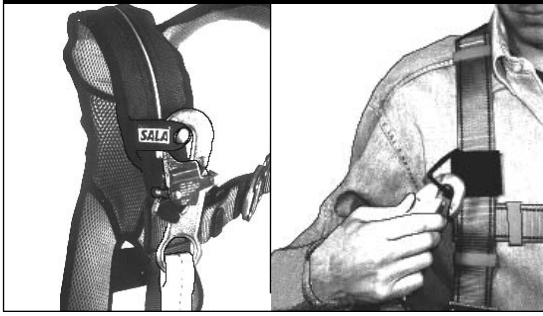
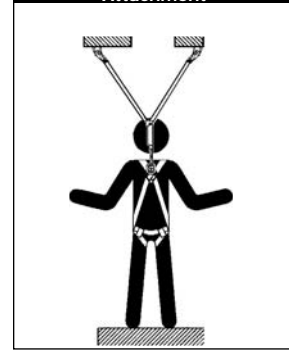
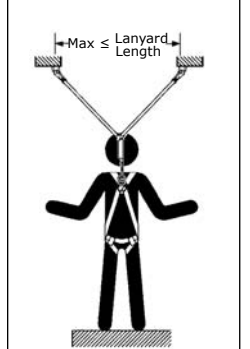


Figure 12 - Acceptable Attachment



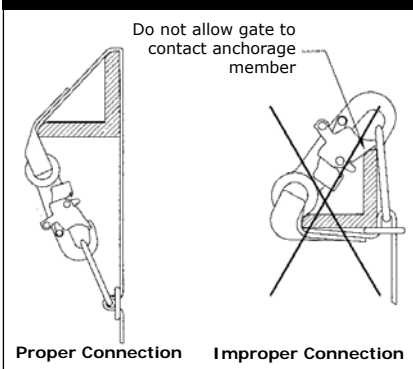
5. When leapfrogging from one anchorage point to the next (such as traversing a horizontal or vertical structure) do not connect to anchorage points that are further apart than the lanyard length (as marked on the lanyard label). See Figure 13.
6. Never connect more than one person to a "Y" type lanyard at a time.
7. Do not allow any lanyard to pass under arms or legs during use.

Figure 13 - Max Lanyard Reach



**Attaching a Tie-Back Lanyard:** See Figure 14. Place the tie-back lanyard over the anchoring structure. Ensure the lanyard is not twisted. Adjust the floating D-ring so it hangs below the anchoring structure. Attach the lanyard end hook to the floating D-ring.

Figure 14 - Attaching Tie-Back

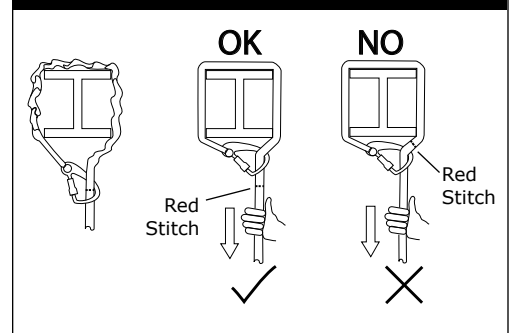


**Attaching a Shockwave 2 Tie-Back Lanyard**

Shockwave 2 Tie-back lanyards (model no. 1244650 and 1244675) are the only Shockwave models suitable for tie back applications. Do not use regular Shockwave 2 models for tie back applications.

Tie back using the captive eye carabiner only. Do not tie back using the snap hook. The snap hook must be connected to the user's harness.

Figure 15 - Shockwave 2 Tie-Back



Anchorage size limit: The red stitching must be outside of the captive eye carabiner when the lanyard is tight around the anchorage (under hand tension). See figure 15.

**WARNING:** Tying back beyond the red stitching will limit the amount of energy absorption in the event of a fall and could result in serious injury or death

If the stitching is located outside of the carabiner, choose an anchorage of smaller size (in accordance with the requirements in section 2.3) to prevent tying back beyond the red stitching.

Ensure the lanyard is cinched tight around the anchorage during use.

**ATTACHING A LANYARD WITH WIRE FORM PIPE HOOK:** The wire form pipe hook is intended for use with pipes up to 3 inches (7.6 cm) in diameter.

The anchorage must be geometrically compatible in size and shape. See Figure 16 for examples of proper and improper connections and intended load directions. Do not side load the pipe hook. Do not allow the pipe hook to contact electrical sources. Squeeze the handle to open the hook. Place hook around the anchorage and release handle. Only use a carabiner as the connecting element when attaching a personal fall arrest system to a pipe hook. When connecting to an anchorage, ensure the hook fully closes and closure hooks engage eye loops on hook body.

- B. **CONNECTING TO THE BODY SUPPORT:** Connect the energy absorbing lanyard or energy absorber to the D-ring on the back between the shoulders (dorsal D-ring) on a full body harness. Connect so the energy absorber portion of the lanyard is on the body support side. DBI-SALA does not recommend using a body belt for fall arrest applications. If using a body belt, connect the energy absorbing lanyard or energy absorber to the D-ring and position the belt so the D-ring is located on the back side of the body.

**ATTACHING A LANYARD WITH WEB LOOPS:** See Figure 17.

1. Insert the energy absorbing lanyard web loop through the harness web loop or D-ring.
2. Insert the opposite end of the energy absorbing lanyard through the connecting web loop.
3. Pull the attached energy absorbing lanyard through the connecting web loop to secure.

**C. CONNECTING TO A ROPE GRAB (FALL ARRESTOR):** It is recommended the lanyard end (vs. the energy absorber end) be attached to the rope grab. This recommendation is made to reduce possible interference with the operation of the rope grab by the energy absorber "pack". Attaching a component style energy absorber to a rope grab is not recommended, with the exception of a "direct-coupling" between a rope grab and a harness. Some rope grabs may be supplied with a permanently attached energy absorbing lanyard. For these cases, use of an additional energy absorber connected between the rope grab and the body support is not recommended. In some cases it may be permissible to couple an energy absorber component between the anchorage (or anchorage connector) and the rope grab lifeline. In all cases, ensure the length of the energy absorber or energy absorbing lanyard does not exceed the rope grab manufacturer's recommended maximum connection length (3 feet [.9 m] maximum per ANSI Z359.1).

**D. CONNECTING TO SELF RETRACTING LIFELINE:** DBI-SALA does not recommend connecting an energy absorbing lanyard or energy absorber component to a self retracting lifeline. Special applications do exist where it may be permissible. Contact DBI-SALA if considering connecting an energy absorbing lanyard to a self retracting lifeline.

**3.4 ADJUSTING THE RETRAX™ LANYARD:** The amount of the lanyard that is retracted into the Retrax housing can be adjusted by completely extending the lanyard from the housing, then sliding the housing up or down the lanyard. See Figure 18. Adjusting the length of lanyard that is retracted into the housing will not reduce the amount of fall clearance needed to arrest a fall. See section 3.2.

**WARNING:** The Retrax lanyard is designed to retract and store the lanyard strap. It is not designed to "lock" or limit the lanyard length in a fall.

**3.5** After use, return the lanyard for cleaning or storage as described in section 6.0

## 4.0 TRAINING

**4.1** It is the responsibility of all users of this equipment to understand these instructions, and to be trained in the correct installation, use, and maintenance of this equipment. These individuals must be aware of the consequences of improper installation or use of this equipment. This user manual is not a substitute for a comprehensive training program. Training must be provided on a periodic basis to ensure proficiency of the users.

**IMPORTANT:** Training must be conducted without exposing the trainee to a fall hazard. Training should be repeated on a periodic basis.

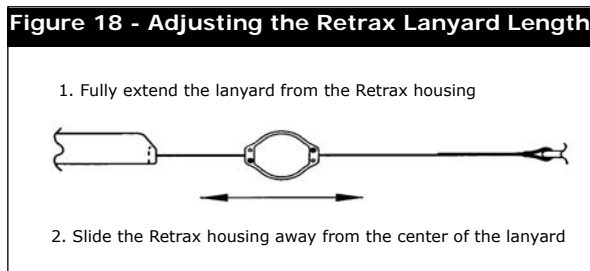
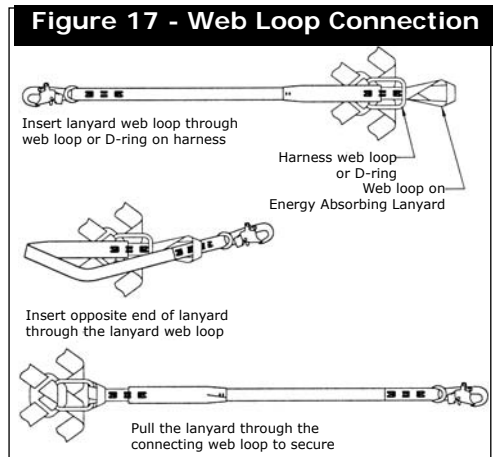
## 5.0 INSPECTION

### 5.1 FREQUENCY

- Before each use visually inspect per steps listed in sections 5.2 and 5.3.
- Annually: The lanyard must be inspected by a competent person (see section 8 Terminology) other than the user at least annually. See sections 5.2 and 5.3 for guidelines. Record the results of each inspection in the inspection and maintenance log in section 9.0, or use the inspection web portal if an i-Safe™ RFID tag is present (see Figure 19). If you are registered i-Safe user, go to [www.capitalsafety.com/isafe](http://www.capitalsafety.com/isafe). For more information contact a Customer Service representative in the US at 1-800-328-6146 or in Canada at 1-800-387-7484.

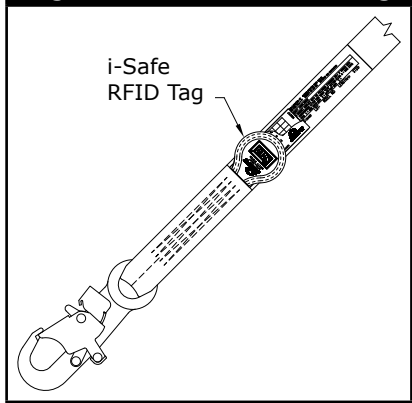
**IMPORTANT:** If the energy absorbing lanyard or energy absorber component has been subjected to fall arrest or impact forces, the user, authorized person, or rescuer must remove it from service immediately and destroy it.

**IMPORTANT:** Extreme working conditions (harsh environment, prolonged use, etc.) may require increasing the frequency of inspections.

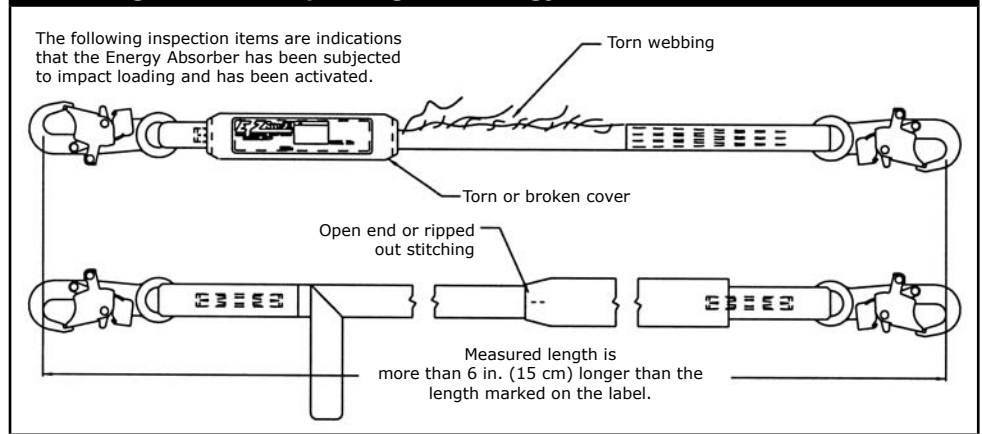




**Figure 19 - i-Safe RFID Tag**



**Figure 20 - Inspecting the Energy Absorber for Activation**



## 5.2 INSPECTION STEPS

- Step 1.** Inspect energy absorbing lanyard or energy absorber component hardware (snap hooks, adjusters, swages, thimbles, etc.). These items must not be damaged, broken, distorted, or have any sharp edges, burrs, cracks, worn parts, or corrosion. Ensure the connecting hooks work properly. Hook gates must move freely and lock upon closing. Ensure adjusters (if present) work properly.
- Step 2.** Inspect the energy absorbing lanyard or energy absorber component per the following as applicable:

**WEBBING AND STITCHING:** The webbing material must be free of frayed, cut, or broken fibers. Check for tears, abrasions, mold, burns, or discoloration, etc. The webbing must be free of knots, excessive soiling, heavy paint buildup, and rust staining. Check for chemical or heat damage indicated by brown, discolored, or brittle areas. Check for ultraviolet damage indicated by discoloration and the presence of splinters or slivers on the webbing surface. All of the above factors are known to reduce webbing strength. Damaged or questionable webbing should be replaced. Inspect stitching for pulled or cut stitches. Broken stitches may be an indication the energy absorbing lanyard or energy absorber component has been impact loaded and must be removed from service.

**WIRE ROPE:** Inspect entire length of the wire rope. Always wear protective gloves when inspecting wire rope. Inspect for broken wires by passing cable through gloved hands, flexing it every few inches to expose breaks. Broken wires can be removed by bending the wire back and forth parallel to the rope length. Do not attempt to pull wires out of rope. Remove the energy absorbing lanyard from service immediately and destroy if there are six or more randomly distributed broken wires in one lay, or three or more broken wires in one strand in one lay. A "lay" of wire rope is the length of wire rope that it takes for a strand (the larger groups of wires) to complete one revolution or twist along the rope. Remove the energy absorbing lanyard from service immediately and destroy if there are any broken wires within 1 inch of the metal compression sleeves (swages) at either end of the assembly. The wire rope should be free of corrosion.

- Step 3. ENERGY ABSORBING COMPONENT:** Inspect energy absorber to determine if it has been activated. There should be no evidence of elongation. See Figure 20. Ensure energy absorber cover is secure and not torn or damaged. On the Shockwave 2™ Lanyard models, the lanyard webbing will tear out to reveal the warning on the impact indicator label. See section 8.2 for label illustration.
- Step 4.** All labels should be present and fully legible. See section 8.0.
- Step 5.** Inspect each system component or subsystem per associated manufacturer's instructions.
- Step 6.** Record the inspection date and results in the inspection log in section 9.0.

- 5.3** If inspection reveals an unsafe condition, remove unit from service immediately and destroy, or contact an authorized service center for repair.

**NOTE:** Only DBI-SALA or parties authorized in writing may make repairs to this equipment.

## 6.0 MAINTENANCE, SERVICING, STORAGE

- 6.1** Clean lanyard with water and a mild detergent solution. Wipe off hardware with a clean, dry cloth, and hang to air dry. Do not force dry with heat. If you have any questions regarding cleaning of this equipment, or require more information, contact DBI-SALA. An excessive buildup of dirt, paint, etc., may prevent the lanyard from working properly, and in severe cases degrade the webbing or rope to a point where it has become weakened and should be removed from service. If you have any questions concerning the condition of your lanyard, or have any doubt about putting it into service, contact DBI-SALA.
- 6.2** Additional maintenance and servicing procedures (replacement parts) must be completed by a factory authorized service center. Authorization must be in writing. Do not disassemble the unit. See section 5.1 for inspection frequency.
- 6.3** Store the lanyard in a cool, dry, clean environment out of direct sunlight. Avoid areas where chemical vapors may exist. Thoroughly inspect the lanyard or energy absorber component after extended storage.

## 7.0 SPECIFICATIONS

- The maximum arresting force of DBI-SALA Energy Absorbing Lanyards and components when dynamically tested in accordance with ANSI Z359.1 is 900 lbs. (4 kN). (EZ STOP® III and ShockWave 2 models less than 6 ft. [1.8 m] in length, maximum arresting force is 1800 lbs. [8 kN], Shockwave 2 Tie-back, maximum arresting force is 1350 lbs [6 kN]).
- The maximum elongation of the Energy Absorbing Lanyard or Energy Absorber component when dynamically tested in accordance with ANSI Z359.1 is 42 in. (1 m).
- Maximum free fall distance must be no greater than 6 ft. (1.8 m) per federal law and ANSI Z359.1
- EZ STOP® II U.S. Patent Number 5,174,410
- 9503175 Self-closing and self-locking snap hook U.S. Patent Number 4,977,647, Can. 2,027,784.

Lanyard Model	Energy Absorber Specifications	Adjustable/ Fixed Length	Lanyard Specifications
Fixed Length EZ Stop II Web Lanyards	1 3/4 in. (4.4 cm) polyester web strength member, tubular nylon web wear pads both ends, nylon outer cover, polyester thread, 8,800 <sup>^</sup> lb. (39.1 <sup>^</sup> kN) tensile strength.	Fixed	1 in. (2.5 cm) polyester web, 8,800 <sup>^</sup> lb. (39.1 <sup>^</sup> kN) tensile strength
Adjustable Length EZ Stop II Web Lanyards	1 3/4 in. (4.4 cm) polyester web strength member, tubular nylon web wear pads both ends, nylon outer cover, polyester thread, 8,800 <sup>^</sup> lb. (39.1 <sup>^</sup> kN) tensile strength.	Adjustable	1 in. (2.5 cm) polyester web, 8,800 <sup>^</sup> lb. (39.1 <sup>^</sup> kN) tensile strength
100% Tie-off EZ Stop II Web Lanyards	1 3/4 in. (4.4 cm) polyester web strength member, tubular nylon web wear pads both ends, nylon outer cover, polyester thread, 8,800 <sup>^</sup> lb. (39.1 kN) tensile strength.	Fixed	1 in. (2.5 cm) polyester web, 100% tie-off, 8,800 <sup>^</sup> lb. (39.1 <sup>^</sup> kN) tensile strength
EZ Stop II Energy Absorber Component	1 3/4 in. (4.4 cm) polyester web strength member, tubular nylon web wear pads both ends, nylon outer cover, polyester thread, 8,800 <sup>^</sup> lb. (39.1 <sup>^</sup> kN) tensile strength.	Fixed	Not Applicable
EZ Stop II Cable Lanyards	1 3/4 in. (4.4 cm) polyester web strength member, nylon web wear pads both ends, nylon outer cover, polyester thread, 8,800 <sup>^</sup> lb. (39.1 <sup>^</sup> kN) tensile strength.	Fixed	7/32 in. (.6 cm) 7x9 galvanized cable, vinyl covered. 5,600 lb. (24.9 kN) tensile strength
EZ Stop III Web Lanyards	1 3/8 in. (3.5 cm) tubular polyester web strength member, nylon web wear pads both ends, polyester thread, 8,800 <sup>^</sup> lb. (39.1 <sup>^</sup> kN) tensile strength.	Fixed	1 3/8 in. (3.5 cm) tubular polyester web strength member, 6,000 lb. (26.7 kN) tensile strength
EZ Stop II Tie-back Web Lanyard	1 3/4 in. (4.4 cm) polyester web strength member, tubular nylon web wear pads both ends, nylon outer cover, polyester thread, 8,800 <sup>^</sup> lb. (39.1 <sup>^</sup> kN) tensile strength.	Fixed	1 in. (2.5 cm) polyester web strength member, 8,800 <sup>^</sup> lb. (39.1 <sup>^</sup> kN) tensile strength with 1 3/8 in. (3.5 cm) tubular polyester web cover
EZ Stop II Tie-back 100% Tie-off Web Lanyard	1 3/4 in. (4.4 cm) polyester web strength member, tubular nylon web wear pads both ends, nylon outer cover, polyester thread, 8,800 <sup>^</sup> lb. (39.1 <sup>^</sup> kN) tensile strength.	Fixed	1 in. (2.5 cm) polyester web strength member, 8,800 <sup>^</sup> lb. (39.1 <sup>^</sup> kN) tensile strength with 1 3/8 in. (3.5 cm) tubular polyester web cover
EZ Stop II Shockwave	1 3/4 in. (4.4 cm) polyester web strength member, tubular nylon web wear pads both ends, nylon outer cover, polyester thread, 8,800 <sup>^</sup> lb. (39.1 <sup>^</sup> kN) tensile strength.	Fixed	1 15/16 in. (4.9 cm) tubular polyester web strength member, 6,000 lb. (26.7 kN) tensile strength
Shockwave 2	1 15/16 in. (4.9 cm) polyester web strength member, nylon web wear pads both ends, polyester thread, 6,000 lb. (26.7 <sup>^</sup> kN) tensile strength.	Fixed	Lanyard and energy absorber are the same material.
Shockwave 2 Tie Back	1 7/8 in. (4.8 cm) polyester web strength member, nylon web wear pads both ends, polyester thread, 8,500 lb. (37.7 <sup>^</sup> kN) tensile strength.	Fixed	Lanyard and energy absorber are the same material.
EZ Stop II Retrax Web Lanyard	1 3/4 in. (4.4 cm) polyester web strength member, nylon web wear pads both ends, nylon outer cover, polyester thread, 6,000 lb. (26.7 kN) tensile strength.	Fixed	1 3/8 in. polyester web, 6,000 lb. (26.7 kN) tensile strength

## 8.0 TERMINOLOGY

**Authorized Person:** A person assigned by the employer to perform duties at a location where the person will be exposed to a fall hazard (otherwise referred to as "user" for the purpose of these instructions).

**Rescuer:** Person or persons other than the rescue subject acting to perform an assisted rescue by operation of a rescue system.

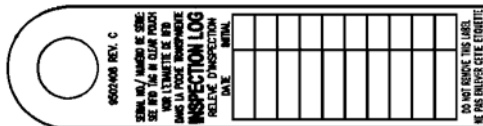
**Certified Anchorage:** An anchorage for fall arrest, positioning, restraint, or rescue systems that a qualified person certifies to be capable of supporting the potential fall forces that could be encountered during a fall or that meet the criteria for a certified anchorage prescribed in this standard.

**Qualified Person:** A person with a recognized degree or professional certificate and with extensive knowledge, training, and experience in the fall protection and rescue field who is capable of designing, analyzing, evaluating and specifying fall protection and rescue systems to the extent required by this standard.

**COMPETENT PERSON:** One who is capable of identifying existing and predictable hazards in the surroundings or working conditions which are unsanitary, hazardous, or dangerous to employees, and who has authorization to take prompt corrective measures to eliminate them.

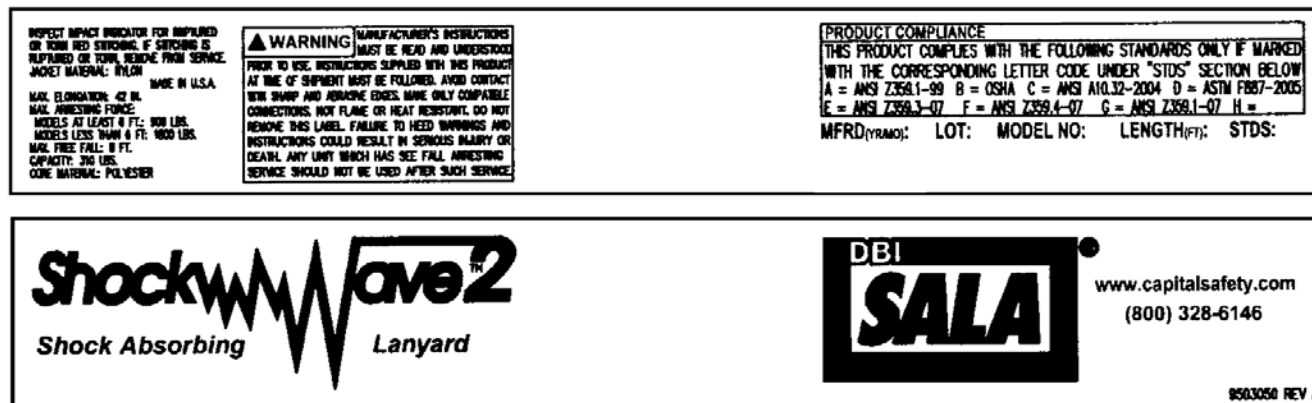
## 9.0 LABELING

9.1 This label must be attached to all lanyards and be fully legible.



All Lanyards - Inspection Log

9.2 These labels must be securely attached to all Shock Wave 2™ Lanyards and be fully legible.

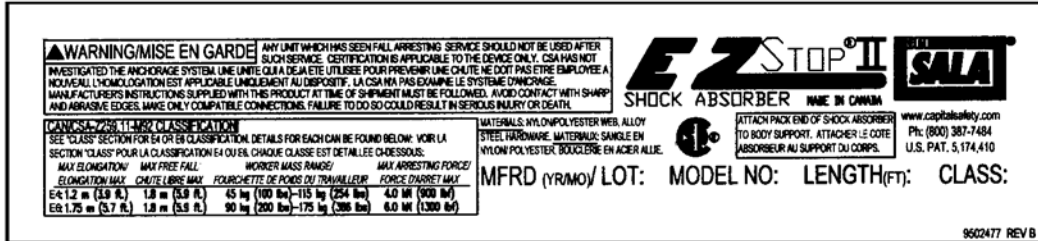


All ShockWave 2 Lanyards - I.D. / Warning Label

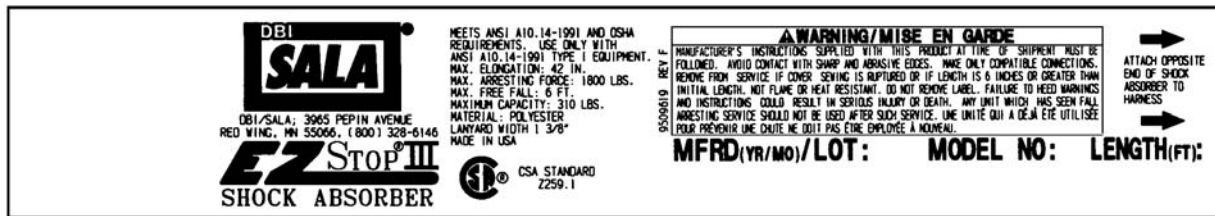
9.3 These labels must be securely attached to the noted CSA approved lanyards and be fully legible.



Warning Label - All CSA Approved Lanyards

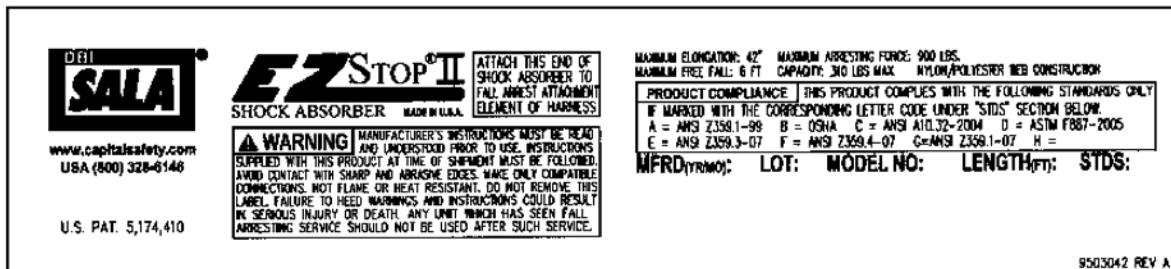


ID / Warning Label - CSA Approved EZ Stop® II Web Lanyards

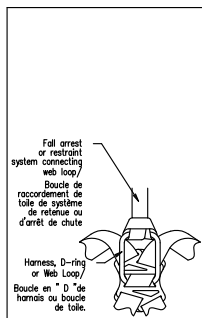


ID Label - CSA Approved EZ Stop® III Web Lanyards

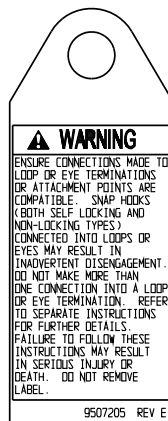
9.4 These labels must be attached to the noted Energy Absorbing Lanyards or Energy Absorber components and be fully legible.



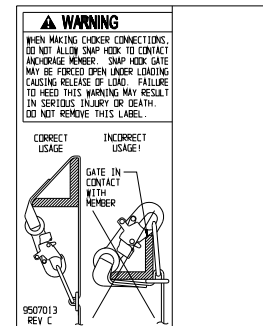
ID Label - EZ Stop® II Web Lanyards



Warning Label - All Web Loop Energy Absorbing Lanyards Not Permanently Attached to Harness



Warning Label - All Web Loop Energy Absorbing Lanyards Permanently Attached to Harness



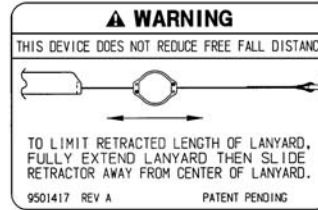
Warning Label EZ Stop® II Tie-Back Lanyards

9.4 CONTINUED . . .

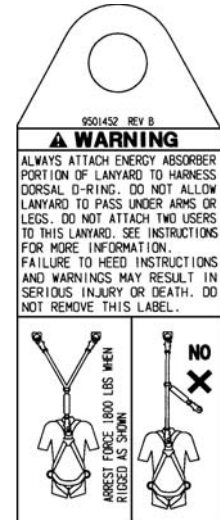
These labels must be attached to the noted Energy Absorbing Lanyards or Energy Absorber components and be fully legible.



Impact Indicator Label  
EZ Stop® Shock Wave 2 Tie-Back Lanyards  
And  
EZ Stop® Shock Wave III Lanyards



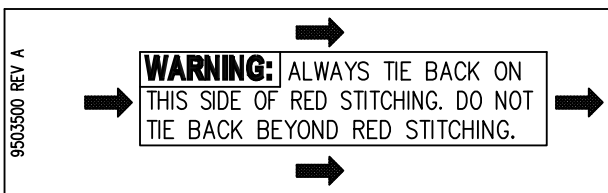
Retrax Warning Label



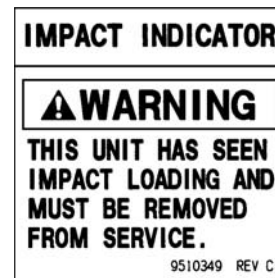
100% Tie-off Lanyard  
Warning Label



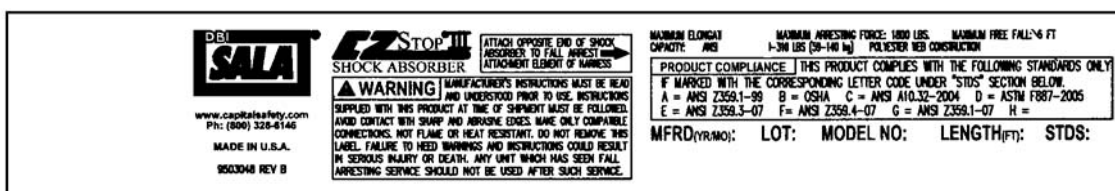
Shockwave 2 Tie Back Lanyards ID Label Front and Back



Shockwave 2 Tie  
Back Lanyards  
Warning Label



Shockwave 2 Tie Back Lanyards  
Impact Indicator Label



All EZ Stop III ANSI Approved Lanyards - I.D. / Warning Label

**10.0 INSPECTION AND MAINTENANCE LOG**

<b>SERIAL NUMBER:</b>			
<b>MODEL NUMBER:</b>			
<b>DATE PURCHASED:</b>			<b>DATE OF FIRST USE:</b>

<b>INSPECTION DATE</b>	<b>INSPECTION ITEMS NOTED</b>	<b>CORRECTIVE ACTION</b>	<b>MAINTENANCE PERFORMED</b>
Approved By:			
Approved By:			
Approved By:			
Approved By:			
Approved By:			
Approved By:			
Approved By:			
Approved By:			
Approved By:			
Approved By:			
Approved By:			
Approved By:			
Approved By:			
Approved By:			
Approved By:			
Approved By:			
Approved By:			
Approved By:			



## Models - CSA:

CSA Class	Model Numbers									
<b>E4:</b>	<b>Max. Arresting Force</b>			<b>Max. Elongation</b>			<b>Min. Mass of Worker</b>		<b>Max. Mass of Worker</b>	
	900 lbf (4.0 kN)			3.9 ft (1.2 m)			100 lbs (45 kg)		254 lbs (115 kg)	
	1100320C	1101859C	1106062C	1108530C	1109433C	1220046C	1220296C	1220680C	1221425C	1224006C
1100321C	1101871C	1106075C	1108534C	1109434C	1220048C	1220297C	1220681C	1221426	1224306C	
1100322C	1102319C	1106203C	1108539C	1109435C	1220054C	1220299C	1220850C	1221426C	1224341C	
1100323C	1102320C	1106684C	1108540C	1109436C	1220058C	1220300C	1220851C	1221460C	1224343C	
1100447C	1102321C	1106685C	1108541C	1109437C	1220068C	1220301C	1220852C	1221461C	1224348C	
1100448C	1102967C	1106689C	1108542C	1110310C	1220071C	1220359C	1220853C	1221480C	1224405C	
1100449C	1102968C	1106690C	1108603C	1110311C	1220074C	1220362C	1220857C	1221481C	1224406C	
1100450C	1102969C	1106698C	1108678C	1110312C	1220079C	1220364C	1220858C	1221484C	1224409C	
1100890C	1102970C	1106699C	1108679C	1110313C	1220080C	1220369C	1220861C	1221801C	1224427C	
1100891C	1102971C	1107160C	1108680C	1110612C	1220086C	1220406C	1220863C	1221802C	1224428C	
1100892C	1103266C	1107161C	1108684C	1110613C	1220091C	1220409C	1220864C	1221803C	1224431C	
1100893C	1103268C	1107162C	1108685C	1110614C	1220092C	1220450C	1220866C	1221804C	1224438C	
1100894C	1103269C	1107163C	1108686C	1110619C	1220093C	1220451C	1220870C	1221805C	1240210C	
1100980C	1103387C	1107164C	1108710C	1110705C	1220098C	1220455C	1220871C	1221806C	1240211C	
1100981C	1103388C	1107165C	1108711C	1110706C	1220105C	1220459C	1220873C	1221807C	1240256C	
1100982C	1103389C	1107837C	1108712C	1220006C	1220108C	1220461C	1220880C	1221808C	1240325C	
1100983C	1103390C	1107838C	1108713C	1220007C	1220115C	1220466C	1220906C	1221809C	1240477C	
1101166C	1103391C	1107839C	1108714C	1220012C	1220132C	1220468C	1220937C	1221810C	1240559	
1101167C	1103392C	1107840C	1108715C	1220016C	1220139C	1220526C	1220938C	1221811C	1244610C	
1101168C	1105855C	1107961C	1109025C	1220017C	1220180C	1220527C	1220939C	1221812C	1244611C	
1101169C	1106015C	1108028C	1109037C	1220024C	1220181C	1220535C	1220940C	1221813C	1244630C	
1101170C	1106040C	1108355C	1109038C	1220028C	1220182C	1220536C	1221001C	1221814C	1244631C	
1101535C	1106041C	1108356C	1109045C	1220030C	1220195C	1220539C	1221006C	1221815C		
1101536C	1106042C	1108357C	1109057C	1220035C	1220204C	1220540C	1221028C	1221816C		
1101537C	1106053C	1108358C	1109058C	1220038C	1220206C	1220553C	1221034C	1221851C		
1101538C	1106054C	1108359C	1109061C	1220040C	1220256C	1220558C	1221104C	1221852C		
1101540C	1106060C	1108528C	1109141C	1220042C	1220259C	1220572C	1221106C	1221853C		
1101851C	1106061C	1108529C	1109432C	1220043C	1220269C	1220601C	1221206C	1221854C		
<b>E6:</b>	<b>Max. Arresting Force</b>			<b>Max. Elongation</b>			<b>Min. Mass of Worker</b>		<b>Max. Mass of Worker</b>	
	1,300 lbf (6.0 kN)			5.7 ft (1.75 m)			200 lbs (90 kg)		386 lbs (175 kg)	
	1242225C	1242227C	1242229C	1242250C	1242325C	1242350C				
1242226C	1242228C	1242230C	1242275C	1242326C	1242375C					

Additional model numbers may appear on the next printing of these instructions.



A Capital Safety Company

**CSG USA**  
3833 Sala Way  
Red Wing, MN 55066-5005  
Toll Free: 800.328.6146  
Phone: 651.388.8282  
Fax: 651.388.5065  
solutions@capitalsafety.com

**CSG Canada Ltd.**  
260 Export Boulevard  
Mississauga, Ontario L5S 1Y9  
Canada  
Toll Free: 800.387.7484  
Phone: 905.795.9333  
Fax: 905.795.8777  
sales.ca@capitalsafety.com

**CSG Northern Europe Ltd.**  
7 Christleton Court • Stuart Rd.  
Manor Park • Runcorn  
Cheshire WA7 1ST • UK  
Phone: +44 (0) 1928 571324  
Fax: +44 (0) 1928 571325  
csgne@csgne.co.uk

**CSG EMEA (France)**  
Le Broc Center  
Z.I. 1ère Avenue-5600 M  
BP 15 • 06511 Carros Cedex  
Phone: +33 (0)4 97 10 00 10  
Fax: +33 (0)4 93 08 79 70  
information@capitalsafety.com

**CSG Asia Pte Ltd.**  
No. 6, Tuas Avenue 18  
Singapore 638892  
Phone: +65 6558 7758  
Fax: +65 6558 7058  
inquiry@capitalsafety.com

**CSG (Aust) Pty Ltd.**  
20 Fariola Street • Sliverwater  
Sydney, NSW 2128  
Australia  
Phone: +61 (2) 9748 0335  
Fax: +61 (2) 9748 0336  
sales@capitalsafety.com.au

[www.capitalsafety.com](http://www.capitalsafety.com)



Certificate No. FM 39709