

# LALIZAS

## INSTRUCTIONS FOR USE

### Lifebuoy Light USCG/SOLAS/MED - ATEX/IECEx

Code 71326



CE 1026



0098

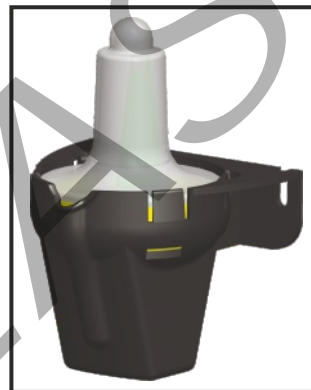

#### ● 1. General Description of the product

The new LALIZAS Intrinsically Safe Lifebuoy light USCG/SOLAS/MED - ATEX/IECEx (71326) is an ideal product to cover the Requirements as set by the 1974 International Convention for the Safety of Life at Sea SOLAS, as last amended, and can be used for all applications that fully accept SOLAS/ MED approved products to be placed onboard.

The Light complies with the mandatory basic performance requirements for Lifebuoy self-igniting Lights, as they are prescribed by the latest version of Maritime Equipment Directive 2014/90/EU, and it has been tested successfully per the requirements of IMO MSC.81 (70) as last amended, ensuring a high level of safety for users of this device. The product is certified per SOLAS/MED (2014/90/EU) by the DNV GL SE -0098.

The product is also certified for protection by **intrinsic safety "i"** for use in an explosive gas atmosphere, which makes it suitable for installation in all hazardous Zones for gas-vapour-mist (0\*, 1 & 2), and all flammable gases (Propane, Ethylene & Hydrogen). Its wide range of operation Temperature between -35°C and +85°C, in combination with its very low maximum Surface Temperature, classifies it as a T4=135°C Temperature Class Equipment i.e. it is safe to be used in explosive atmospheres containing gases with auto ignition Temperatures  $\geq 135^{\circ}\text{C}$ .

The product complies with the requirements of ATEX Directive 2014/34/EU, as well as with the International Scheme IECEx for Explosion Protection and it was tested under the following Standards EN 60079-0:2018, EN 60079-11:2012, EN 60079-28:2015 The product is certified per ATEX/IECEx by FTZU 12ATEX 0157X.

#### Key Features:

- Level of Protection: ia
- Group Subdivision: IIC
- Maximum Surface Temperature Class: T4=135°C
- Equipment Protection Level Ga/Category 1/ Zone 0

The LALIZAS Lifebuoy light USCG/SOLAS/MED - ATEX/ IECEx (71326) consists of a sealed enclosure providing Ingress Protection Rating (IP66/68), two lithium batteries (3.0V) connected in parallel, which in combination with a powerful LED, can provide flashing light of white color with a luminous intensity of at least 2.0Cd in all directions of the upper hemisphere, for at least 2 hours. Furthermore, the product features a Holding bracket, a magnetic switch with a ripcord that is mounted to the holding bracket and a lanyard of 2m attached on its one side to the Light's enclosure and passing through the Lanyard recess of the holding bracket, is to be attached on its other side to the Lifebuoy ring.

\* The device shall not be installed in a location where external conditions are conducive to the build-up of electrostatic charge.

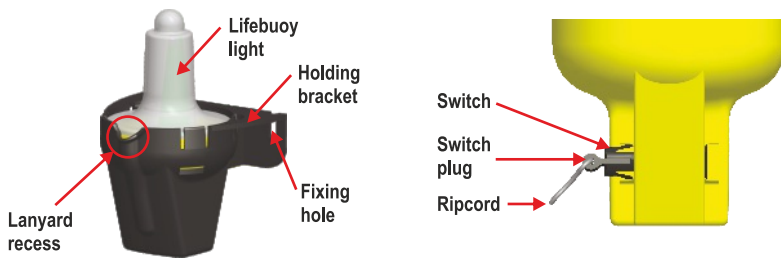

**Fig 1: Parts Description**

The Lifebuoy Light USCG/SOLAS/MED- ATEX/ IECEx (71326) is activated automatically after being pulled from its holding bracket by the act of deployment of the lifebuoy and has been drop tested from a **stowage height of 80m** highly exceeding the LSA Code requirements!

## ● 2. Operation of the product

### 2.1 Installation of the Lifebuoy Light 71326 onboard

The 71326 lifebuoy light can be mounted in permanent or semi-permanent way (Fig 2). To mount the light permanently, screw the holding bracket to a mounting surface through the two fixing holes. Alternatively for semi-permanently mounting a LALIZAS "fixed mount support" code 99826 can be used. After mounting this support, you can slide the holder base in (Fig 2). The lifebuoy light can be semi-permanently mounted on rails too, using the LALIZAS rail support code 99824. Mount the support to the rails and then slide the holder base in (Fig 2). In all the above options the mounting position should be such that the lifebuoy light installation height is not bigger than the installation height of the lifebuoy and that there are no obstacles to affect the lifebuoy light fall in the water.

#### Permanent mounting of 71325 & 71326 holding base

For permanent mounting of the holding base just fix the base on the surface you want with the two fixing holes (red arrows)

#### Fixed Mount and Rail Support for "Store-All" Cases

These supports allow you to mount the "Store-All" cases semi-permanently. All you have to do is mount the support on the surface or the rails you want and then slide in the case. When you do not want to use the case, just remove it. The support will remain in the surface until the next time you need it.

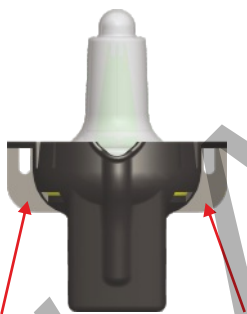

Rail Support Base for "Store-All" Cases - Graphite

99824

99826

Fixed Mount Support Base for "Store-All" Cases - Graphite



1



2



3



4

**Fig 2: Mounting Options**

After installation of the holding bracket using one of the above ways, secure the lanyard to the lifebuoy ring (Fig 3). Then remove carefully the lifebuoy light from its holder base to ensure that the switch plug is fitted in the switch (Fig 1).



**Fig 3: Lifebuoy Light Lanyard connected securely to the Lifebuoy Ring**

Push the switch to "ON" position and check that the light operated efficiently (Fig 4).

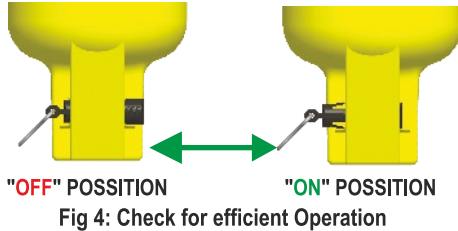

Fig 4: Check for efficient Operation

Afterwards ensure that the switch plug is fitted in the switch housing (Fig 1) and turn the switch in "OFF" position again. Fit the light into the bracket with the switch side to the back and the lanyard in the front (Fig 5).

**WARNING:** Ensure that the lanyard is placed in recess (Fig 1 & Fig 6). Any other way of installation might affect the proper release of the lifebuoy light. Refer to Part 4 - Inspection Process for proper installation.



Fig 5: Holding Bracket Orientation

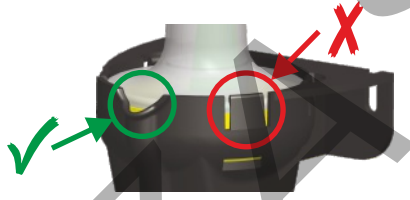

Fig 6: Correct Recess for the Lanyard in the Holder Bracket

## 2.2 Instructions for Use

The 71326 lifebuoy light is attached with a lanyard to a lifebuoy ring (Fig 3), which when thrown into the sea, pulls the lifebuoy light from its holding bracket and switches it "ON" automatically. During the deployment, the lifebuoy sweeps along the lifebuoy light from its holding bracket and a ripcord (Fig 1 & Fig 4) switches "ON" the light providing a flashing light of at least 2,0 Cd in all directions of the upper hemisphere for more than 2 hours and an average flashing frequency of 0,88Hz.

## 3. Storage

The 71326 lifebuoy lights must be stored in a dark, clean, dry area. They must not be compressed in storage. Store between -35°C and +85°C.

## 4. Inspection Process

The 71326 lifebuoy light USCG/SOLAS/MED-ATEX/IECEx is maintenance free. However, during the mandatory Monthly Inspections that must be carried out by a ship's crew member on the Lifesaving Appliances, it is recommended the 71326 lifebuoy light USCG/SOLAS/MED-ATEX/IECEx to be inspected as well, in order to ensure its good condition. The Inspection Method is the following:

1. Inspect the product visually to ensure that the holder base and the light are undamaged. If the unit is damaged, you need to replace it.
2. Extract gently the light from the holder base and check that the switch plug is fitted on the switch (Fig 7).

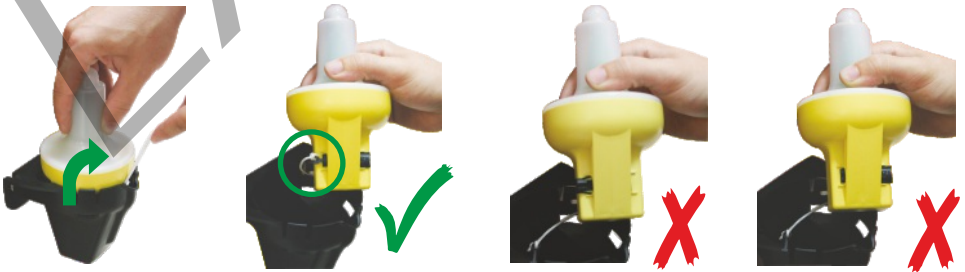

Fig 7: Fig Extraction of the Lifebuoy Light from the holding bracket and switch plug check

3. Manually push the switch to the ON position (Fig 4) and check that the light operates efficiently. If the light does not operate, it needs to be replaced.

4. Ensure that the switch plug is fitted in the switch housing and turn the switch to the OFF position again (Fig 1 & Fig 4).

5. Fit the light into the bracket with the switch side to the back and the lanyard to the front (Fig 5).

### Important Notes:

Ensure that the lanyard is placed in recess. Any other way of installation might affect the proper release of the lifebuoy light (Fig 6). Periodical operational testing must last only a few seconds to avoid consuming of the battery voltage.

## 5. Replacement

The 71326 Lifebuoy light USCG/SOLAS/ MED- ATEX/IECEx is a compact product, i.e. its battery cannot be replaced. The shelf life of the product is 5 years from the manufacturing date. Beyond this date the product must be replaced. If the light is thrown into the sea for rescue, it is then considered used and needs to be replaced.

**Health and Safety Information** Lalizas Lifebuoy Light (71326) contains Lithium cells i.e. hermetically sealed, pressurized primary Lithium/Manganese cells, electrically protected by a solid state device as well as environmentally protected by a moulded plastic housing. Also the product is compact as the shell of the light is hermetically bonded and cannot open unless the light is damaged. In this sense, the unit poses no definable hazard to health.

The recommended Temperature range within which the lithium battery and therefore the whole product must be stored is between -35°C and +85°C. Furthermore, the product must be handled as follows:

- Do not dismantle the light assembly!
- Do not make any external electrical connection!
- Do not recharge!
- Do not incinerate!
- Do not tamper!
- Do not heat above 212°F (100°C)!

Dispose the used and expired lights in accordance with local regulations.

## 6. Technical Data of Lifebuoy Light USCG/SOLAS/MED- ATEX/IECEx- 71326

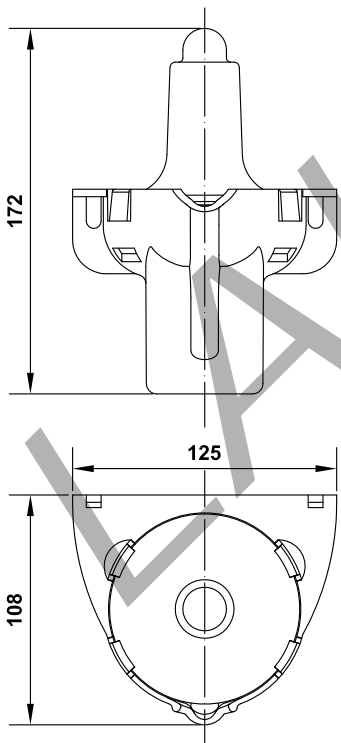

<b>Product Code</b>	71326
<b>Product name</b>	Lifebuoy light USCG/SOLAS/MED- ATEX/ IECEx
<b>Temperature Class</b> (Maximum Surface Temperature)	T4=135°C
<b>Intrinsically Safe</b>	 II 1G Ex ia op is IIC T4 Ga
<b>Approvals</b>	USCG/SOLAS/MED- ATEX/ IECEx
<b>Color</b>	Yellow
<b>Activation</b>	Automatic via Pull Cord
<b>Luminous Intensity</b>	Minimum 2.0 cd
<b>Duration</b>	Minimum 2 hours
<b>Type</b>	Flashing LED
<b>Material - Lifebuoy light</b>	Polycarbonate
<b>Material - Holder</b>	Antistatic Polypropylene
<b>Battery</b>	2 Lithium Batteries
<b>Weight with holder</b>	290g
<b>Drop Height</b>	80 meters
<b>Operation Temperature</b>	-35°C < To < +85°C
<b>Degree of protection</b>	IP66/68
<b>Storage Lifetime</b>	5 years